

800W LED Framing Moving Head

USER MANUAL

(RDM TFT DISPLAY)



CONTENTS

Chapter 1 Installation and attention	1
1. Maintenance	1
2. Statement	1
3. Safety Precaution	1
4. Cable connection (DMX)	1
5. Rigging (Optional)	2
6. RDM Note	3
Chapter 2 Panel operation	4
1. Brief	4
2. Operation	4
1. Operate fixture with button	4
2. Parameter value setting	5
3. Boolean parameter setting	5
4. Sub Menu (Parameter)	6
3. Operation and parameter instruction	6
1. DMX Address setting	6
2. Fixture operating mode setting	7
3. Set display	8
4. Scene	9
5. Set light run parameter	10
6. Status and information	11
Chapter 3 Channel description	13
1. Channel table	13

Chapter 1 Installation and attention

1. Maintenance

- To reduce the risk of electrical shock or fire, do not expose this unit to rain or moisture.
- Intermittently using will extend this item's service life.
- Please clear the fan, fan net, and optical lens in order to keep good work state.
- Do not use the alcohol or any other organic solvent to wipe the shell.

2. Statement

The product has perfect performance and integrity packing. All users should be strictly complying with the warning and operating instructions as stated. Any result by misusing is not within the Company's warranty. Any fault or problem caused by neglecting the manual is also not in the charge of dealers.

Note: All information is subject to change without prior notice.

3. Safety Precaution

- In order to guarantee the product's life, please don't put it in the damp places or even the environment over 60 degrees.
- Always install this unit in safe and stable matter.
- Install or dismantle should operate by professional engineer.
- Using lamp, the change rate of power voltage should be within $\pm 10\%$. If the voltage is too high, it will shorten the light's life; if it's not enough, will influence the effect.
- Please restart it 20 minutes later after turning off light, until full-cooling. Frequent switching will reduce the life span of lamps and bulbs; intermittent using will improve the life of bulbs and lamps.
- In order to make sure the product is used well, please read the Manual carefully.

4. Cable connection (DMX)

Use a cable conforming to specifications EIA RS-485: 2-pole twisted, shielded, 120Ohm characteristic impedance, 22-24 AWG, low capacity. Do not use microphone cable or cables with different specified characteristics. The end connections must be made using XLR type 3 or 5-pin male/female connectors. A terminating plug must be inserted into the last projector with a resistance of 120Ohm (minimum 1/4 W) between terminals 2 and 3. Figure 1 shows a signal line connection diagram (the fixture in the figure is an example picture and doesn't represent the real exterior of this product).

IMPORTANT: The wires must not make contact with each other or with the metal casing of the connectors. The casing itself must be connected to the shield braid and to pin 1 of the connectors.

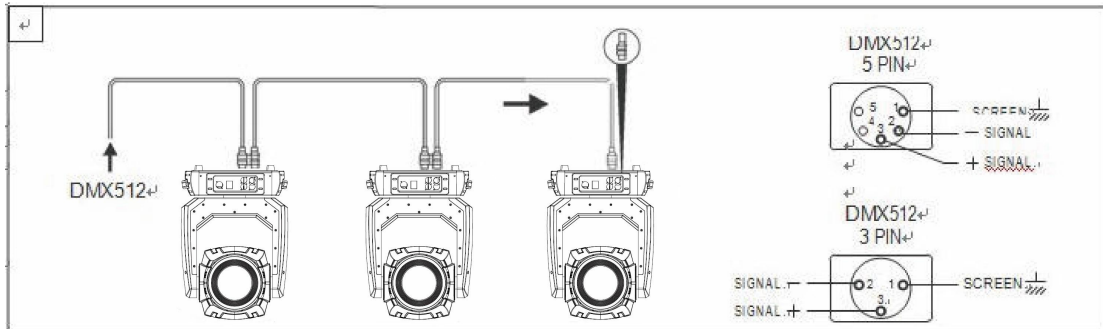

Figure 1 DMX Cable connection

5. Rigging (Optional)

As shown in Figure 2 (the fixture in the figure is an example picture and does not represent the real exterior of this product), this equipment can be positioned and fixed by clamp in every direction of the stage. Locking system makes it easy to fasten to the bracket.

Attention! Two clamps is needed to fix the equipment. Every clamp is locked by fastener of 1/4 kind. Fastener can only be locked clockwise.

Attention! Fasten a safety string to the additional hole of side aluminum piece. The secondary accessory can not hang on the delivery handle. Nip the equipment on bracket.

- Check if rigging clamp (not including the one inside) damaged or not? If stand ten times weight as the equipment. Make sure the architecture can stand ten times weight as all the equipments, clamps, wirings and other additional fixtures.
- Screws for clamping must be fixed firmly. Take one M12 screw (Grade 8.8 or higher) to clamp bracket, and then screw the nuts.
- Level the two hanging points at the bottom of clamp. Insert fastener to the bottom, lock the two levers by 1/4 rotating clockwise; then install another clamp.
- Install on safety string which stands at least ten times weight as equipment. Terminal of the accessory is designed for clamps.
- Make sure pan/tilt lock unlocked or not. Keep the distance more than 1M from equipment to flammable material or lighting source.

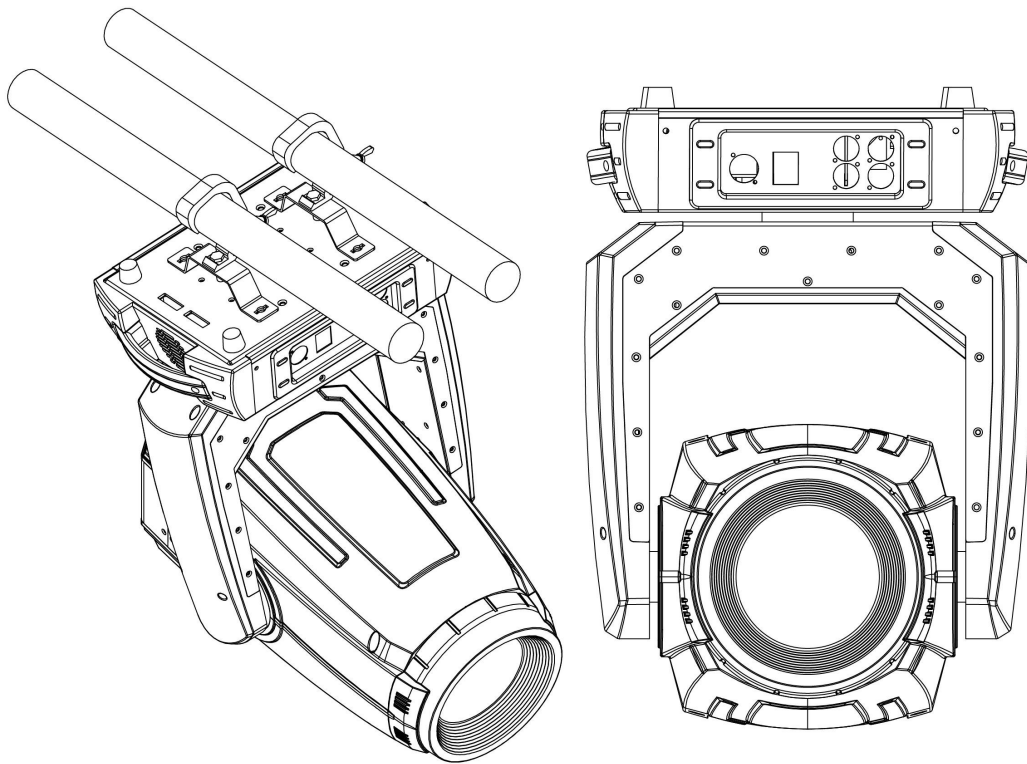

Figure 2 Installation

6. RDM Note

RDM is an extended version of DMX512-A protocol. It is a remote device management protocol. Traditional DMX512 protocol communication is one-way communication. The protocol is based on RS-485 bus. RS-485 is a time-sharing multi-point, half-duplex protocol. Only one port is allowed to output at the same time. So, when using RDM, we should pay attention to it. The following points:

- To use console or host device that supports RDM host protocol.
- Use bidirectional signal amplifier, traditional one-way signal amplifier is not suitable for RDM protocol, because the RMD protocol needs feedback data, the use of one-way amplifier will block the return of data, resulting in no search fixture;
- All fixture must be set to DMX mode to ensure only one host on the cable.
- A 120 ohm impedance matching resistor must be inserted between terminals 2 and 3 of the terminal plug. When the signal line is longer, reducing the signal reflection will make the differential signal more stable and beneficial to the quality of communication.
- When the fixture appears to accept DMX control, but can not been search by RDM host, first check the signal amplifier, and then check whether the signal line 2, 3 lines have bad contact.

Chapter 2 Panel operation

1. Brief

The light panel diagram show as Figure 3, above area is Title for fixture description, the black font in the lower right corner shows the fault status of the fixture (when the fault information is not viewed, it displays "ERR", otherwise it displays "NOR"), and the status bar below shows the signal of the current fixture , lamp status, communication status, etc. (the panel in the figure is an example picture and does not represent the real outside of the product panel, please select a panel of the same type as your product for reference.).

RDM protocol is embed in fixture, user set DMX address via cable using the controller support RDM function. when fixture was search by controller, displayer will echo 'RDM' indicate this RDM is work.

Note: Prevent damage the touch or TFT displayer, Can not use sharp objects chick displayer.

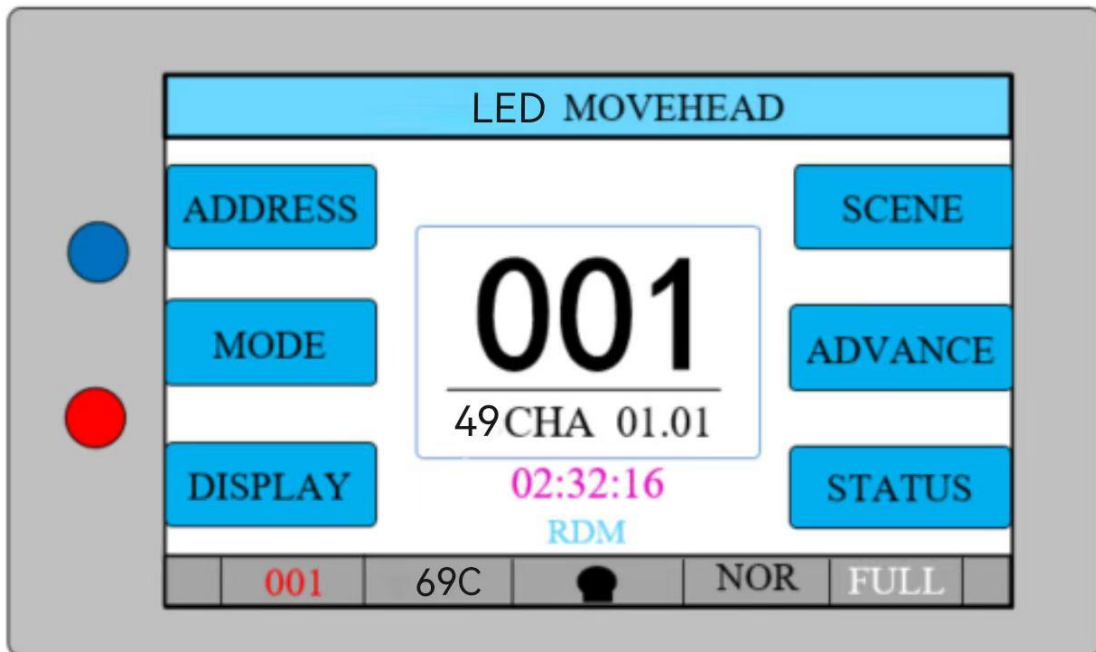

Figure 3 Panel diagram

2. Operation

1. Operate fixture with button

- The left area is TFT Displayer , can view parameters and status.
- There are three operation modes, which are common buttons, touch buttons, and knobs. The operation method of touch buttons is the same as that of common buttons. The up and down button move the cursor to select parameters, press the OK button to confirm, and press the Exit button to return. If a knob is used, rotating in different directions can control the cursor up or down, and pressing the knob can confirm. If you want to go back, rotate the knob to move the cursor to the position of the Escape on the display, press the knob to confirm and return.

2. Parameter value setting

When the selected item is value need to be modified, the dialog shown in Figure 4 will popup.

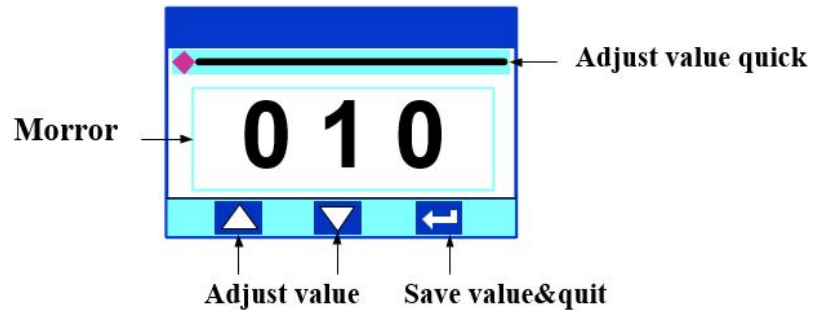

Figure 4 Dialog of value setting

- **Modify value:** Can quickly modify value via pull the slider to the desired position, or click the button of 'up' or 'down' whit finger on the right side to set the exact desired value, another way is roll encoder on the right hand side of panel.
- **Save Value:** Any time, click on the lower right corner of the "OK" button, the setting will be saved into internal memory.

3. Boolean parameter setting

- when the selected parameters is a Boolean value (such as ON or OFF), can directly modify setting by chick corresponding item, the setting will been saved right now.
- When the parameter is a key item, chick corresponding item, a dialog shown in Figure 5 will be popup ask for the confirm. Chick 'sure' to confirm.

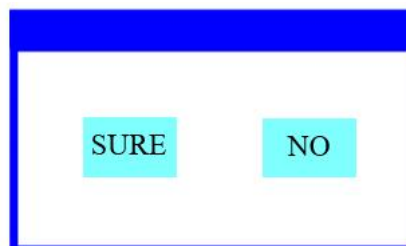

Figure 5 Dialog of confirm

4. Sub Menu (Parameter)

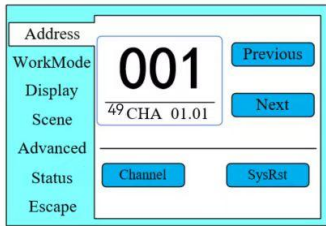

Figure 6-1 Address setting

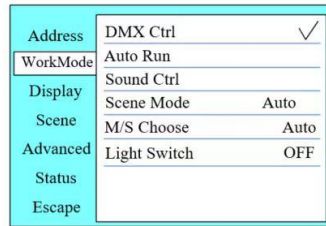

Figure 6-2 Run Settings

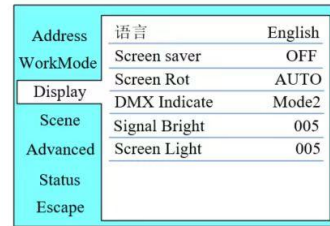

Figure 6-3 Display Settings

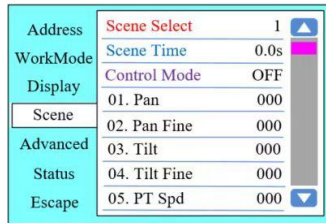

Figure 6-4 Scene Settings

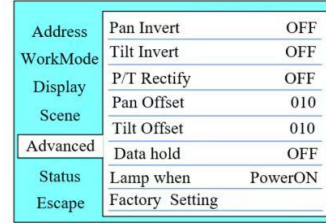

Figure 6-5 Advanced setting

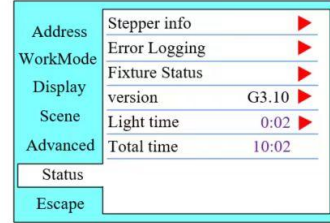

Figure 6-6 Status Settings

Figure 6 Parameter menu

3. Operation and parameter instruction

In the main interface, you can enter the corresponding parameter setting interface by selecting six buttons.

1. DMX Address setting

Enter page show in Figure 6-1, can set fixture DMX address, channel mode and so on.

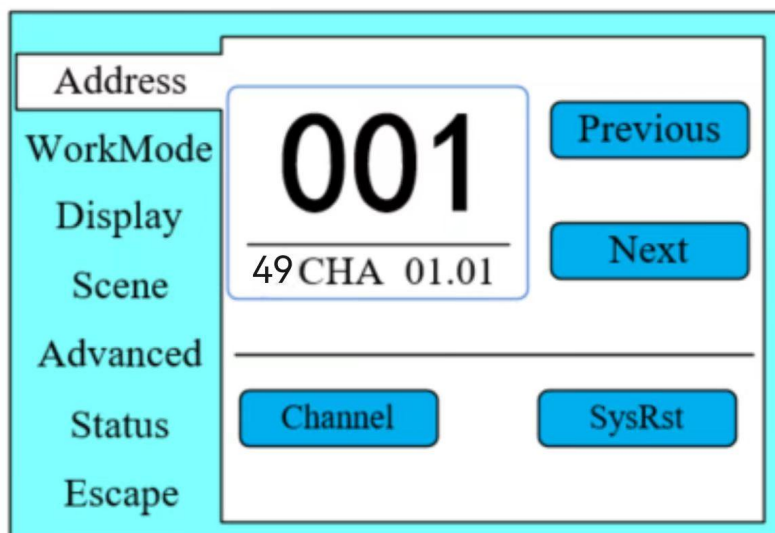

Figure 6-1

The menu settings of fixture have optimized the setting of addresses. Several settings of the address are as follows:

- Select " previous " or "next", the fixture will be based on the current address and channel

- mode, automatically calculate the next or last address, make address setting can quickly;
- Click on the address agree, you can enter the numeric editing window, where you can set any valid address, fixture system automatically get the current number of channels, automatically filter the unusable address (512 - the current number of channels).
- Fixture support RDM protocol, remote address can be set through RDM.

Provide two buttons:

- Channel mode: you can choose different channel modes by cycle.
- Fixture reset: reset all motors. Set Light work mode

2. Fixture operating mode setting

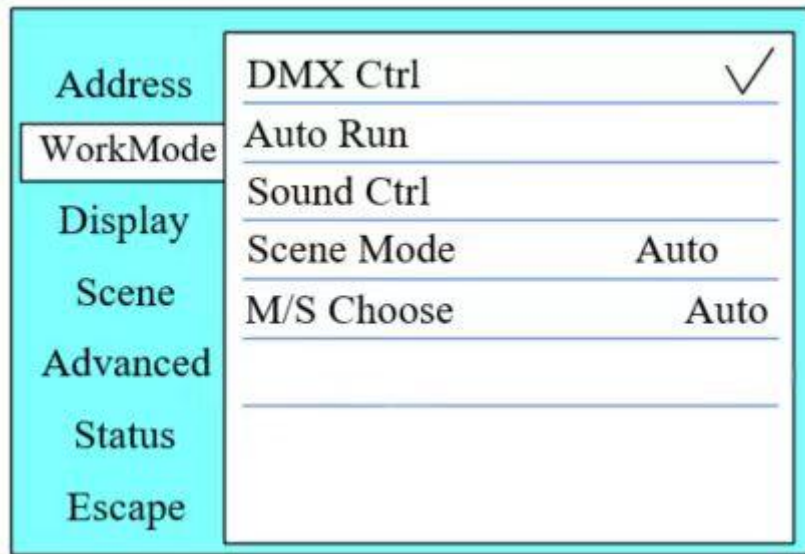

Figure 6-2

Through the page shown in Figure 6-2, the operating mode of the fixture can be set and the lamp can be controlled. The fixture supports four operating modes (DMX mode, auto mode, voice control mode and scene mode). Detailed parameter settings can be refer in the previous section. Specific parameter descriptions are as follows:

operating mode

DMX Ctrl	DMX mode, receive DMX signal, RDM signal	
Auto Run	Fixture run automatically according to built-in programs	
Sound Ctrl	When the fixture detects a strong sound, the fixture automatically runs a scene according to the built-in program, otherwise it will stay the last scene	
Scene Mode 01	runs in a set scene, which supports most of the custom editing of 10 scenes.	
	1~10	outputs the specified scene
	Auto	Automatically loops the output scene in the set scene time (non-zero) order, and the scene with time 0 automatically ignore
M/S Choose	Master and slave selection, non-DMX mode takes effect, select the mode of data output, fixture detect DMX cable state automatic switch output, prevent data conflicts	
	Master	fixture runs built-in program. If DMX has no signal, it outputs data (synchronization), otherwise it does not output data.
	Slave	Fixture runs built-in program and do not output data

	Auto	If DMX has no signal, the fixture will runs built-in program. Otherwise, the fixture will run in DMX Mode(follow DMX).
Lamp switch		(Lamp light source) pop-up confirmation dialog box, select "SURE" to confirm the current operation, turn on or off the lamp, switch time interval limited to 30 seconds
	Off	the current lamp output is off
	On	The current lamp output is turned on

Scene mode applies to a single or a small number of fixture, just output a fixed scene, or need to run a simple program, you no need connect to the console, in the scene page can be edited.

If the light source is lamp, wait for 10 minutes before turning off the lamp.

3. Set display

Address	语言	English
WorkMode	Screen saver	OFF
	Screen Rot	AUTO
Display	DMX Indicate	Mode2
Scene	Signal Bright	005
Advanced	Screen Light	005
Status		
Escape		

Figure 6-3

The fixture support Chinese and English, invert display and so on. Enter the corresponding parameter settings as shown in Figure 6-3. The specific menu contents are as follows:

DISPLAY SETTING

Language	display language settings	
	English	English display
	Chinese	Chinese display
Screen saver	Set screen 30 seconds without operation, the screen's display content or method.	
	OFF	Keep the last operation page
	Mode1	Black
	Mode2	Black screen, showing the address code of the current fixture in the lower left corner.
	Mode3	Display trademark information, address code and operation mode.
	Mode4	Display trademark information, address code and operation mode,which lasts for 30 seconds ,black screen.
Screen Rot	Set the display direction of the screen.	
	OFF	No reverse display
	ON	Reverse display
	AUTO	Automatically detect the direction of lamps and automatically switch direction.
DMX Indicate	Set the indication mode of DMX signal indicator.	
	Mode1	When signal is bright, no signal is off.

	Mode2	When signal is off, no signal is bright.
	Mode3	When signal is flash, no signal is off.
Signal Bright	Set the brightness of the signal indicator	
	1~10	10
Screen Light	Set the screen backlight for 10 seconds without operation	
	1~10	10

4. Scene

Enter the page shown in Figure 6-4(The channel shown in the picture is only an example of the function, please refer to the channel table description in the next section for the specific channel table of this product), and the fixture enters the scene editing mode. For example,under this page,when the [Control Mode] option is turned off ,the fixture does not receive DMX console data, and the edited data will effect on the fixture immediately.When it turned on, the console signal is received and the console data is read and reflected on the corresponding channel display.

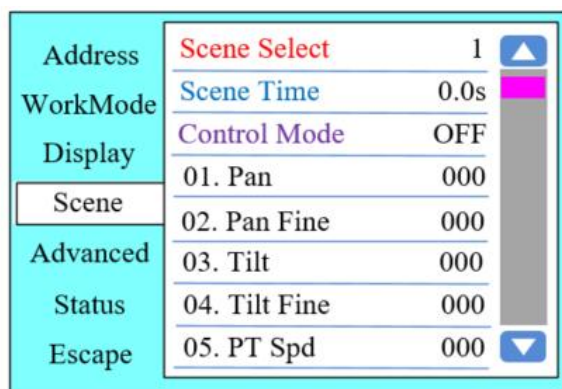

Figure 6-4

The content of the page depends on the currently selected channel mode, and the channel content and order displayed are consistent with the fixture channel table. Through this page, you can edit 10 scenes, as shown in the following table:

SCENE MODE

Scene Select	Select the current operation scenario.	
	1~10	The 10 scenes sets the format
Scene Time	Sets the retention time of the current scene when it is automatic,the final time is determined by the scene time multiplier, unit in 0.1 seconds.	
	0	The current scene is not output in automatic scene output.
	1-255	0..1s-25.5s
Control Mode	Choose whether to use the console to manipulate the settings data	
	OFF	It is not possible to control the console and set the data directly from the current interface
	ON	Using console control, the console data comes first when setting, and the setting is invalid in the current interface
1. PAN	0-255	Set up the data of each channel, and the contents and order of the display are one-to-one correspondence with the channel list of fixture.
.....	0-255	
.....	0-255	

N. Function	0-255	
--------------------	-------	--

If the reset channel in the scene edits the effective reset data, the fixture will reset, but after reset, the corresponding reset channel value will automatically set 0, preventing multiple consecutive resets.

Looking at this page, you can get the current channel table slot of the fixture. For specific channel data, please refer to the detailed channel description.

5. Set light run parameter

Address	Pan Invert	OFF
	Tilt Invert	OFF
WorkMode	P/T Rectify	OFF
	Pan Offset	010
Display	Tilt Offset	010
	Data hold	OFF
Scene	Lamp when	PowerON
	Factory Setting	
Advanced		
Status		
Escape		

Figure 6-5

Enter the page shown in Figure 6-5, adjust the field parameters of fixture, facilitate the installation of fixture, etc.

ADVANCED SETTING

Pan Invert	Set the rotation direction of PAN	
	OFF	
	ON	
Tilt Invert	Set the rotation direction of TILT	
	OFF	
	ON	
P/T Rectify	Setting up fixture to detect XY lost step and correct	
	OFF	Uncorrected position after out of step
	ON	After losing step, the position is automatically corrected and the out of step fault is recorded.
Pan Offset	Setting the zero point of the PAN of the fixture	
	4-150	
Tilt Offset	Setting the zero point of the TILT of the fixture	
	4-48	
Data hold	When the fixture is not equipped with DMX signal, the output state of the fixture	
	OFF	No signal, so the motor and light source return to the position and state when reset is completed.
	ON	No signal, keep the last frame DMX data output.
Scene Time (multiple)	Work with the scene time to determine the scene retention time	
	1-255	Retention time = Scene time * multiple
Lamp mode	Set the way to first open the lamp after power up	

	Power on	Turn on the lamp at power up and reset the lamp after 30 seconds.
	After reset	Reset the fixture after 3 seconds when power-on, and turn on the lamp after reset.
	Manual	After reset, manually turn on the lamp through the menu or console.
Factory Setting	Pop up the confirmation box, select "SURE", and return the lamp parameters to the factory settings.	

When choosing power-on mode, the lamp will wait for 30 seconds after power-on, let the lamp fully start, internal voltage is stable enough, then start the reset program, if the field capacity is stable, recommend power-on mode.

When the fixture can not calibrate the position, please check whether the "P/T Rectify" is turned off.

When the signal is unplugged, check the Data Hold setting first if the position of the fixture is not output as expected.

When setting the XY offset, after setting up, please control XY with the maximum stroke first to check that XY will not bump into the positioning rod or shell.

6. Status and information

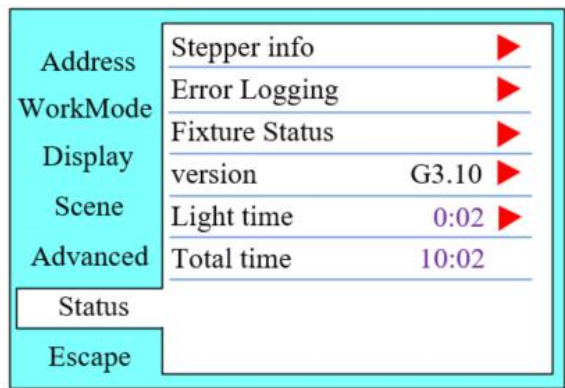

Figure 6-6

Entering the page shown in Figure 6-6, you can view the information and real-time status of the fixture to get their usage status. If the fixture need customer service, please provide the status information displayed on the page as a basis for judgment, as shown in the following table:

STATUS INFORMATION

Stepper info	Display information status of all motors and signals in fixture.	
	Hall	No display, indicating that the motor has no Hall, 0 indicating that the motor leaves the correction position point, 1 indicating that the motor is in the correction position point
	Status	Display motor reset status
	PAN	Display real-time position value of PAN optocoupler feedback
	TILT	Display real-time position value of TILT optocoupler feedback
	PAN OP	Displays the PAN TILT optocoupler two signal level state, binary
Error Logging	Show the latest 8 error records when the fixture is reset and running. The error records are not saved after power failure. The current power cycle is valid.	
	Error Logging	Total number of failures detected after power on

	12: :03	The time of power failure when the fault occurs is in minutes.
	Hall error	The effective hall signal is not detected when the motor is reset
	Hall short	When the motor is reset, the hall signal of the motor is always effective
	Opti error	No effective optocoupler signal is detected when the motor is reset.
	Lose stop	The corresponding motor is out of step during its operation.
	Hit	Striking the positioning rod when the motor is reset
	Lamp error	Lamp explosion accident
	NTC error	The temperature sensor signal is abnormal
	Fan error	The main fan is not working properly.
Fixture status	Displays the critical state data of the current fixture for reference.	
	Communication prec	0~100%, Communication quality of internal data link of lamps and lanterns
	Error Cnt	The number of erroneous frames was detected after power on, and the total number of erroneous frames was detected.
	Light Temperature	Show the temperature of the current light source, "---" means no detection.
	Panel Temperature	Displays the temperature of the current display panel or the ambient temperature.
	Sensor1 Temperature	Display the ambient temperature of the motherboard temperature or the motherboard installation position.
Version	Display the information and version of the current fixture, important reference for after sales maintenance.	
	Device	The name of the fixture is the same as the equipment information of RDM.
	Model	The type of fixture is the same as the model information of RDM.
	Panel	Firmware version and serial number of display panel
	Main Board	Firmware version and serial number of mother board 1
Light time	Record the total cumulative time of light source opening, unit minute, user manual cleaning, as a reference for regular maintenance of light source time	
Total time	The total accumulated time for recording the opening of fixture is not allowed to be removed.	

Chapter 3 Channel description

1. Channel table

This fixture channel can be viewed in scene mode in order, channel mode is set in the "Address Settings" page, specific details of the data as follows:

DMX protocol

DMX protocol			
Version: 1.4 Mode 1 - Standard 16 bit, Mode 2 - Reduced 8 bit			
Quick overview of default DMX values for each channel			
Mode/channel		Default DMX Value	Function
1	2		
1	1	128	Pan
2	2	0	Pan Fine
3	3	128	Tilt
4	4	0	Tilt fine
5	5	0	Pan/Tilt speed , Pan/Tilt time
6	6	0	Power/Special functions
7	7	10	LED frequency selection
8	8	128	LED frequency fine adjusting
9	9	0	Max. light intensity indication and setting
10	10	0	Colour wheel 1
11	*	0	Colour wheel 1-fine positioning
12	11	0	Colour wheel 2
13	*	0	Colour wheel 2-fine positioning
14	12	0	Cyan
15	13	0	Magenta
16	14	0	Yellow
17	15	0	CTO
18	16	0	Virtual colour wheel
19	17	0	Effects speed
20	18	0	CMY+CTO+Colour wheels time
21	19	0	Static gobo/ Framing shutters/Zoom/Focus/Iris/Frost/Prism time
22	20	0	Effect wheel positioning
23	21	128	Effect wheel rotation
24	22	0	Effect wheel animations
25	23	0	Static gobo wheel
26	24	0	Rotating gobo wheel
27	25	128	Rot. gobo indexing and rotation
28	*	0	Rot. gobo indexing/rotation - fine
29	26	0	Prism
30	27	128	Prism indexing/rotation
31	28	0	Frost
32	29	0	Iris
33	*	0	Iris - fine
34	30	128	Zoom
35	*	0	Zoom - fine
36	31	128	Focus
37	*	0	Focus - fine
38	32	128	Framing shutters module rotation
39	33	0	Framing shutter 1- movement
40	34	128	Framing shutter 1- swivelling
41	35	0	Framing shutter 2- movement
42	36	128	Framing shutter 2- swivelling
43	37	0	Framing shutter 3 movement

DMX protocol

Mode/channel		Default DMX Value	Function	
1	2			
44	38	128	Framing shutter 3- swivelling	
45	39	0	Framing shutter 4 movement	
46	40	128	Framing shutter 4- swivelling	
47	41	32	Shutter/ strobe	
48	42	0	Dimmer intensity	
49	*	0	Dimmer intensity - fine	
Mode/channel		DMX Value	Function	Type of control
1	2			
1	1		Pan	
		0 - 255	Pan movement by 540° (128=default)	proportional
2	2		Pan Fine	
		0 - 255	Fine control of pan movement (0=default)	proportional
3	3		Tilt	
		0 - 255	Tilt movement by 280° (128=default)	proportional
4	4		Tilt fine	
		0 - 255	Fine control of tilt movement (0=default)	proportional
5	5		Pan/Tilt speed , Pan/Tilt time	
		0	Standard mode (0=default)	step
		1	Max. Speed Mode	step
			Pan/Tilt speed mode	
		2 - 255	Speed from max. to min.	proportional
			Pan/Tilt time mode	
		2 - 255	Time from 0.2 sec. to 25.5 sec.	proportional
6	6		Power/Special functions	
			Factory display menu setting: DMX Input-Wired ,Graphic display-On, Pan/tilt Mode-Speed,Blackout while pan/tilt moving-Off, Blackout while gobo wheels moving-Off,Blackout while colour wheels moving-Off, Fans mode-Auto	
		0 -9	Reserved (0=default)	
			<i>To activate following functions, stop in DMX value for at least 3 s and shutter must be closed at least 3 sec. (Channel „Shutter/ Strobe“ 47/41 must be at range: 0-31 DMX). Corresponding menu items are temporarily overwritten.</i>	
		10-14	DMX input: Wired DMX *	step
		15-19	DMX input: Wireless DMX *	step
			* function is active only 10 seconds after switching the fixture on	
		20-24	Graphic display: On	step
		25-29	Graphic display: Off	step
		30-39	Reserved	step
		40-44	Pan/Tilt mode: Speed	step
		45-49	Pan/Tilt mode: Time	step
		50-54	Blackout while pan/tilt moving: On	step
		55-59	Blackout while pan/tilt moving: Off	step
		60-64	Blackout while gobo wheels moving: On	step
		65-69	Blackout while gobo wheels moving: Off	step
		70-74	Blackout while colour wheels moving: On	step
		75-79	Blackout while colour wheels moving: Off	step

DMX protocol

Mode/channel		DMX Value	Function	Type of control
1	2			
		80-84	Fans mode: Auto	step
		85-89	Fans mode: High	step
		90-94	High-power mode: On	step
		95-99	High power mode: Off	step
		100-109	Reserved	
		110-114	Dimmer curve: Square law	step
		115-119	Dimmer curve: Linear	step
		120-124	Parking position On	step
		125-129	Parking position Off	step
			<i>To activate following functions, stop in DMX value for at least 3 seconds.</i>	
		130 - 139	Fixture reset (except pan/tilt)	
		140 - 149	Pan/Tilt reset	step
		150 - 159	Colour system reset	step
		160 - 169	Gobo wheels/effect wheel reset	step
		170 - 179	Reserved	
		180 - 189	Zoom/focus/frost/prism reset	step
		190 - 199	Iris /framing shutters reset	step
		200 - 209	Total fixture reset	step
		210-224	Reserved	
			The following RoboSpot related commands are only applicable when the RoboSpot is connected:	
		225 - 229	RoboSpot enabled	step
		230 - 234	RoboSpot disabled - except handle faders and pan/tilt	step
		235 - 239	RoboSpot fully disabled	step
		240	Disabled "Quiet mode"	step
		241 - 255	Quiet mode - fan noise control from min. to max.	proportional
7	7		LED frequency selection	
			Factory display menu setting: 600Hz	
			<i>Select PWM output frequency of LEDs. Selected PWM frequency can be fine adjusted in 127 steps up/down around selected PWM frequency on the channel below. Corresponding menu item (Frequency Setup) is temporarily overridden.</i>	
		0-4	PWM frequency from Display menu (fixture utilizes PWM frequency set in the display menu item Frequency Setup).	step
		5-9	300 Hz	step
		10-14	600 Hz (10=default)	step
		15-19	1200 Hz	step
		20-24	2400 Hz	step
		25-255	Reserved (fixture utilizes PWM frequency set in the display menu item Frequency Setup).	
8	8		LED frequency fine adjusting	
			Factory display menu setting: 600Hz	
			<i>Select desired PWM output frequency of LEDs on the channel above.</i>	
		0-1	Selected LED Frequency	step
		2	LED Frequency (step -126)	step
		3	LED Frequency (step -125)	step
		4	LED Frequency (step -124)	step
		:		
		125	LED Frequency (step -3)	step

DMX protocol

Mode/channel		DMX Value	Function	Type of control
1	2			
		126	LED Frequency (step -2)	step
		127	LED Frequency (step -1)	step
		128	Selected LED Frequency (128=default)	step
		129	LED Frequency (step +1)	step
		130	LED Frequency (step +2)	step
		131	LED Frequency (step +3)	step
		:		
		252	LED Frequency (step +124)	step
		253	LED Frequency (step +125)	step
		254	LED Frequency (step +126)	step
		255	Selected LED Frequency	step
9	9		Max. light intensity indication and setting	
		0-10	No function (0=default)	
		11-20	Indication of drop of max. light intensity	step
			<i>A drop of max. light intensity of the fixture (compared to its original intensity) is indicated by a corresponding colour output: 0-5%, (WHITE /new LED module/) 6-10% (RED) 11-15% (GREEN) 16-20% (BLUE) 21-25% (CYAN) 26-30% (MAGENTA) 31-35% (YELLOW) 36-40% (ORANGE) Pan/tilt/zoom is set at 128 DMX (50%), Dimmer is open at 255 DMX (100%).</i>	
			<i>To set a drop of max. light intensity (compared to original light intensity), stay at DMX value for at least 3 sec. and shutter must be closed at least 3 sec. (Channel „Shutter/Strobe“ 47/41 must be at range: 0-31 DMX). Corresponding menu items are permanently overwritten.</i>	
		21-30	Set drop by 6-10% (RED)	step
		31-40	Set drop by 11-15% (GREEN)	step
		41-50	Drop by 16-20% (BLUE)	step
		51-60	Set drop by 21-25% (CYAN)	step
		61-70	Set drop by 26-30% (MAGENTA)	step
		71-80	Set drop by 31-35% (YELLOW)	step
		81-90	Set drop by 36-40% (ORANGE)	step
		91-100	Original intensity (WHITE)	step
		101-255	Reserved	
10	10		Colour wheel 1	
			Continual positioning	
		0	Open/white (0=default)	proportional
		21	Deep red	proportional
		43	Deep blue	proportional
		64	Orange	proportional
		86	Green	proportional
		107	Congo blue	proportional

DMX protocol

Mode/channel		DMX Value	Function	Type of control
1	2			
		128-129	Open/White	step
			Positioning	
		130-141	Deep red	step
		142-153	Deep blue	step
		154-165	Orange	step
		166-177	Green	step
		178-189	Congo blue	step
		190 - 215	Forwards rainbow effect from fast to slow	proportional
		216 - 217	No rotation	step
		218 - 243	Backwards rainbow effect from slow to fast	proportional
		244 - 249	Random colour selection by audio control	step
			(Set microphone sensitivity in menu „Personality“)	
		250 - 255	Auto random colour selection from fast to slow	proportional
11	*		Colour wheel 1 - fine positioning	
		0 - 255	Fine positioning (0=default)	proportional
12	11		Colour wheel 2	
			Continual positioning	
		0	Open/white (0=default)	proportional
		21	Multicolour	proportional
		43	Laser green	proportional
		64	Lavender	proportional
		86	Filter CRI 80	proportional
		107	Filter CRI 90	proportional
		128-129	Open/White	step
			Positioning	
		130-141	Multicolour	step
		142-153	Laser green	step
		154-165	Lavender	step
		166-177	Filter CRI 80	step
		178-189	Filter CRI 90	step
		190 - 215	Forwards rainbow effect from fast to slow	proportional
		216 - 217	No rotation	step
		218 - 243	Backwards rainbow effect from slow to fast	proportional
		244 - 249	Random colour selection by audio control	step
			(Set microphone sensitivity in menu „Personality“)	
		250 - 255	Auto random colour selection from fast to slow	proportional
13	*		Colour wheel 2 - fine positioning	
		0 - 255	Fine positioning (0=default)	proportional
14	12		Cyan	
		0 - 255	Cyan from min. saturation --> full cyan (0=default)	proportional
15	13		Magenta	
		0 - 255	Magenta from min. saturation --> full magenta (0=default)	proportional
16	14		Yellow	
		0 - 255	Yellow from min. saturation --> full yellow (0=default)	proportional
17	15		CTO filter	
		0 - 255	CTO from 6700K --> 3000K (0=default)	proportional
18	16		Virtual colour wheel	
		0	No function (0=default)	step

DMX protocol

Mode/channel		DMX Value	Function	Type of control
1	2			
		1-2	Filter 4 (Medium Bastard Amber)	step
		3-4	Filter 10 (Medium Yellow)	step
		5-6	Filter 19 (Fire)	step
		7-8	Filter 26 (Bright Red)	step
		9-10	Filter 58 (Lavender)	step
		11-12	Filter 68 (Sky Blue)	step
		13-14	Filter 71 (Tokyo Blue)	step
		15-16	Filter 79 (Just Blue)	step
		17-18	Filter 88 (Lime Green)	step
		19-20	Filter 90 (Dark Yellow Green)	step
		21-22	Filter 100 (Spring Yellow)	step
		23-24	Filter 101 (Yellow)	step
		25-26	Filter 102 (Light Amber)	step
		27-28	Filter 103 (Straw)	step
		29-30	Filter 104 (Deep Amber)	step
		31-32	Filter 105 (Orange)	step
		33-34	Filter 106 (Primary Red)	step
		35-36	Filter 111 (Dark Pink)	step
		37-38	Filter 115 (Peacock Blue)	step
		39-40	Filter 116 (Medium Blue-Green)	step
		41-42	Filter 117 (Steel Blue)	step
		43-44	Filter 118 (Light Blue)	step
		45-46	Filter 119 (Dark Blue)	step
		47-48	Filter 120 (Deep Blue)	step
		49-50	Filter 121 (Filter Green)	step
		51-52	Filter 128 (Bright Pink)	step
		53-54	Filter 131 (Marine Blue)	step
		55-56	Filter 132 (Medium Blue)	step
		57-58	Filter 134 (Golden Amber)	step
		59-60	Filter 135 (Deep Golden Amber)	step
		61-62	Filter 136 (Pale Lavender)	step
		63-64	Filter 137 (Special Lavender)	step
		65-66	Filter 138 (Pale Green)	step
		67-68	Filter 139 (Primary Green)	step
		69-70	Filter 141 (Bright Blue)	step
		71-72	Filter 147 (Apricot)	step
		73-74	Filter 148 (Bright Rose)	step
		75-76	Filter 152 (Pale Gold)	step
		77-78	Filter 154 (Pale Rose)	step
		79-80	Filter 157 (Pink)	step
		81-82	Filter 158 (Deep Orange)	step
		83-84	Filter 162 (Bastard Amber)	step
		85-86	Filter 164 (Flame Red)	step
		87-88	Filter 165 (Daylight Blue)	step
		89-90	Filter 169 (Lilac Tint)	step
		91-92	Filter 170 (Deep Lavender)	step
		93-94	Filter 172 (Lagoon Blue)	step
		95-96	Filter 179 (Chrome Orange)	step

DMX protocol

Mode/channel		DMX Value	Function	Type of control
1	2			
		97-98	Filter 180 (Dark Lavender)	step
		99-100	Filter 181 (Congo Blue)	step
		101-102	Filter 197 (Alice Blue)	step
		103-104	Filter 201 (Full C.T. Blue)	step
		105-106	Filter 202 (Half C.T. Blue)	step
		107-108	Filter 203 (Quarter C.T. Blue)	step
		109-110	Filter 204 (Full C.T. Orange)	step
		111-112	Filter 205 (Half C.T. Orange)	step
		113-114	Filter 206 (Quarter C.T. Orange)	step
		115-116	Filter 247 (Filter Minus Green)	step
		117-118	Filter 248 (Half Minus Green)	step
		119-120	Filter 281 (Three Quarter C.T. Blue)	step
		121-122	Filter 285 (Three Quarter C.T. Orange)	step
		123-124	Filter 352 (Glacier Blue)	step
		125-126	Filter 353 (Lighter Blue)	step
		127-128	Filter 715 (Cabana Blue)	step
		129-130	Filter 778 (Millennium Gold)	step
		131-132	Filter 793 (Vanity Fair)	step
		133-255	Reserved	
19	17		Effects Speed <i>Speed of CMY&CTO movement and Rot. Gobo/Static Gobo selection</i>	
		0-255	Speed of CMY+CTO movement from max. to min. (0=default)	proportional
		0-255	Speed of Rot. Gobo/Stat. Gobo selection from max. to min.	proportional
20	18		CMY+CTO+Colour wheels time	
		0	Function is off (0=default)	step
		1 - 255	Time of CMY, CTO and Colour wheels movement (0.1sec-->25.5sec.)	proportional
21	19		Static gobo wheel/ Framing shutters/Zoom/Focus/Iris/Frost/Prism time	
		0	Function is off (0=default)	step
		1-255	Time of Static gobo movement (0.1 sec-->25.5 sec.)	proportional
		1 - 255	Time of framing shutters, zoom, focus, iris and frost movement (0.1 sec-->25.5 sec.)	proportional
		1-50	Time of prism movement (0.1 sec-->5 sec.)	proportional
22	20		Effect wheel positioning	
		0-19	No function (0=default)	step
		20-127	Proportional indexing (73-center)	proportional
		128-170	Ramping from open to full position (max--->min. speed)	proportional
		171-213	Ramping from open to half position (max. --->min. speed)	proportional
		214-255	Ramp. from half position to full position (max. --->min. speed)	proportional
23	21		Effect wheel rotation	
		0	No rotation	step
		1 - 127	Forwards rotation from fast to slow	proportional
		128	No rotation (128=default)	step
		129 - 255	Backwards rotation from slow to fast	proportional
24	22		Effect wheel animations	
		0-7	No animation (0=default)	

DMX protocol

Mode/channel		DMX Value	Function	Type of control
1	2			
			<i>Note : Set suitable DMX value at Focus channel to get desired animation. All animations were created at distance of 5 m from screen with zoom=128 DMX, Focus value is different for each effect (focus value is stated in parentheses for this distance)</i>	
			<i>The following channels are blocked: Effect wheel positioning, Effect wheel rotation, Static gobo wheel. Rotating gobo wheel, Rot. Gobo indexing and rotation, Rot. Gobo wheel fine rotation.</i>	
		8-9	Macro 1 (Focus=159)	step
		10-11	Macro 2 (Focus=144)	step
		12-13	Macro 3 (Focus=146)	step
		14-15	Macro 4 (Focus=160)	step
		16-17	Macro 5 (Focus=181)	step
		18-19	Macro 6 (Focus=181)	step
		20-21	Macro 7 (Focus=166)	step
		22-23	Macro 8 (Focus=142)	step
		24-25	Macro 9 (Focus=151)	step
		26-27	Macro 10 (Focus=152)	step
		28-255	Reserved	
25	23		Static gobo wheel	
		0-8	Open/hole (0=default)	step
		9-17	Gobo 1	step
		18-26	Gobo 2	step
		27-35	Gobo 3	step
		36-44	Gobo 4	step
		45-53	Gobo 5	step
		54-62	Gobo 6	step
		63-71	Gobo 7	step
		72-80	Gobo 8	step
		81-91	Gobo 9	step
			<u>Shaking gobos from slow to fast</u>	
		92-103	Gobo 1	proportional
		104-115	Gobo 2	proportional
		116-127	Gobo 3	proportional
		128-139	Gobo 4	proportional
		140-151	Gobo 5	proportional
		152-163	Gobo 6	proportional
		164-175	Gobo 7	proportional
		176-187	Gobo 8	proportional
		188-199	Gobo 9	proportional
		200 - 201	Open/hole	step
		202 - 222	Forwards gobo wheel rotation from fast to slow	proportional
		223 - 243	Backwards gobo wheel rotation from slow to fast	proportional
		244 - 249	Random gobo selection by audio control <i>(Set microphone sensitivity in menu „Personality“)</i>	step
		250 - 255	Auto random gobo selection from fast to slow	proportional
26	24		Rotating gobo wheel	
			<i>Index - set indexing on channel 27/25</i>	
		0-3	Open/hole (0=default)	step
		4-7	Gobo 1	step

DMX protocol

Mode/channel		DMX Value	Function	Type of control
1	2			
		8-11	Gobo 2	step
		12-15	Gobo 3	step
		16-19	Gobo 4	step
		20-23	Gobo 5	step
		24-27	Gobo 6	step
		28-31	Gobo 7	step
			<i>Rotation - set rotation on channel 27/25</i>	
		32-35	Gobo 1	step
		36-39	Gobo 2	step
		40-43	Gobo 3	step
		44-47	Gobo 4	step
		48-51	Gobo 5	step
		52-55	Gobo 6	step
		56-59	Gobo 7	step
			<i>Shaking gobos from slow to fast</i>	
			<i>Index - set indexing on channel 27/25</i>	
		60 - 69	Gobo 1	proportional
		70 - 79	Gobo 2	proportional
		80 - 89	Gobo 3	proportional
		90 - 99	Gobo 4	proportional
		100 - 109	Gobo 5	proportional
		110 - 119	Gobo 6	proportional
		120 - 129	Gobo 7	proportional
			<i>Shaking gobos from slow to fast</i>	
			<i>Rotation - set rotation on channel 27/25</i>	
		130 - 139	Gobo 1	proportional
		140 - 149	Gobo 2	proportional
		150 - 159	Gobo 3	proportional
		160 - 169	Gobo 4	proportional
		170 - 179	Gobo 5	proportional
		180 - 189	Gobo 6	proportional
		190 - 199	Gobo 7	proportional
		200 - 201	Open/hole	step
		202 - 221	Forwards gobo wheel rotation from fast to slow	proportional
		222 - 223	No rotation	step
		224 - 243	Backwards gobo wheel rotation from slow to fast	proportional
		244 - 249	Random gobo selection by audio control (Set microphone sensitivity in menu „Personality“)	step
		250 - 255	Auto random gobo selection from fast to slow	proportional
27	25		Rot. gobo indexing and rotation	
			<i>Gobo indexing - set position on channel 26/24</i>	
		0 - 255	Gobo indexing	proportional
			<i>Gobo rotation - set position on channel 26/24</i>	
		0	No rotation	step
		1 - 127	Forwards gobo rotation from fast to slow	proportional
		128	No rotation (128=default)	step
		129 - 255	Backwards gobo rotation from slow to fast	proportional
28	*		Rot. gobo indexing/rotation - fine	

DMX protocol

Mode/channel		DMX Value	Function	Type of control
1	2			
		0-255	Fine indexing/rotation (0=default)	proportional
29	26		Prism	
		0 - 19	Open position - hole (0=default)	step
		20 - 73	Prism indexing	step
		74-127	Prism rotation	step
			Prism/gobo macros	
			<i>The following channels are blocked: Prism, Prism rotation, Static gobo wheel, Rotating gobo wheel, Rot. Gobo indexing and rotation, Rot. Gobo wheel fine rotation.</i>	
		128 - 135	Macro 1	step
		136 - 143	Macro 2	step
		144 - 151	Macro 3	step
		152 - 159	Macro 4	step
		160 - 167	Macro 5	step
		168 - 175	Macro 6	step
		176 - 183	Macro 7	step
		184 - 191	Macro 8	step
		192 - 199	Macro 9	step
		200 - 207	Macro 10	step
		208 - 215	Macro 11	step
		216 - 223	Macro 12	step
		224 - 231	Macro 13	step
		232 - 239	Macro 14	step
		240 - 247	Macro 15	step
		248 - 255	Macro 16	step
30	27		Prism indexing/rotation	
			Prism indexing - set position on channel 29/26	
		0 - 255	Prism 1 indexing	proportional
			Prism rotation - set position on channel 29/26	
		0	No rotation	step
		1 - 127	Forwards prism rotation from fast to slow	proportional
		128	No rotation (128=default)	step
		129-255	Backwards prism rotation from slow to fast	proportional
31	28		Frost	
		0	Open (0=default)	step
			Light Frost	
		1-50	Light Frost from 0% to 100%	proportional
		51-53	100% Light Frost	step
		54-63	Pulse closing from slow to fast	proportional
		64-73	Pulse opening from fast to slow	proportional
		74-83	Ramping from fast to slow	proportional
		84-86	Open	step
			Medium Frost	
		87-136	Medium Frost from 0% to 100%	proportional
		137-139	100% Medium Frost	step
		140-149	Pulse closing from slow to fast	proportional
		150-159	Pulse opening from fast to slow	proportional
		160-169	Ramping from fast to slow	proportional

DMX protocol

Mode/channel		DMX Value	Function	Type of control
1	2			
		170-172	Open	step
			Combined Frost	
		173-222	Medium Frost from 0% to 100% (Light Frost inserted)	proportional
		223-225	100% Medium Frost (Light Frost inserted)	step
		226-235	Pulse closing from slow to fast	proportional
		236-245	Pulse opening from fast to slow	proportional
		246-255	Ramping from fast to slow	proportional
32	29		Iris	
		0	Open (0=default)	step
		1 - 179	From max. diameter to min. diameter	proportional
		180 - 191	Closed	step
			Pulse effects with Iris blackout	
		192 -219	Pulse opening from slow to fast	proportional
		220 - 247	Pulse closing from fast to slow	proportional
		248 - 249	Random pulse opening (fast)	step
		250 - 251	Random pulse opening (slow)	step
		252 - 253	Random pulse closing (fast)	step
		254 - 255	Random pulse closing (slow)	step
33	*		Iris - fine	
		0 - 255	Fine iris movement (0=default)	proportional
34	30		Zoom	
		0 - 255	Zoom from max. to min. beam angle (128=default)	proportional
35	*		Zoom - fine	
		0-255	Fine zooming (0=default)	proportional
36	31		Focus	
		0 - 255	Continuous adjustment from far to near (128=default)	proportional
37	*		Focus - fine	
		0- 255	Fine focusing (0=default)	proportional
38	32		Framing shutters module rotation	
		0-127	Rotation from right (0°) to 60°	proportional
		128	Centre (128=default)	step
		129-255	Rotation from 60° to left (120°)	proportional
39	33		Framing shutter 1- movement	
		0-255	Movement from Outward to Inward (0=default)	proportional
40	34		Framing shutter 1- swivelling	
		0-127	Swivelling from -30 degrees towards 0 degrees	proportional
		128	0 degrees (128=default)	step
		129-255	Swivelling from 0 degrees to +30 degrees	proportional
41	35		Framing shutter 2- movement	
		0-255	Movement from Outward to Inward (0=default)	proportional
42	36		Framing shutter 2- swivelling	
		0-127	Swivelling from -30 degrees towards 0 degrees	proportional
		128	0 degrees (128=default)	step
		129-255	Swivelling from 0 degrees to +30 degrees	proportional
43	37		Framing shutter 3 movement	
		0-255	Movement from Outward to Inward (0=default)	proportional
44	38		Framing shutter 3- swivelling	
		0-127	Swivelling from -30 degrees towards 0 degrees	proportional

DMX protocol

Mode/channel		DMX Value	Function	Type of control
1	2			
		128	0 degrees (128=default)	step
		129-255	Swivelling from 0 degrees to +30 degrees	proportional
45	39		Framing shutter 4 movement	
		0-255	Movement from Outward to Inward (0=default)	proportional
46	40		Framing shutter 4- swivelling	
		0-127	Swivelling from -30 degrees towards 0 degrees	proportional
		128	0 degrees (128=default)	step
		129-255	Swivelling from 0 degrees to +30 degrees	proportional
47	41		Shutter/ strobe	
		0 - 31	Shutter closed	step
		32 - 63	Shutter open (32=default)	step
		64 - 95	Strobe-effect from slow to fast	proportional
		96 - 127	Shutter open	step
		128 - 143	Opening pulse in sequences from slow to fast	proportional
		144 - 159	Closing pulse in sequences from fast to slow	proportional
		160 - 191	Shutter open	step
		192 - 223	Random strobe-effect from slow to fast	proportional
		224 - 255	Shutter open	step
48	42		Dimmer intensity	
		0 - 255	Dimmer intensity from 0% to 100% (0=default)	proportional
49	*		Dimmer intensity - fine	
		0 - 255	Fine dimming (0=default)	proportional

Colours on Virtual Colour Wheel					
Colour name	Col. Wheel 1 DMX	Col. Wheel 2 DMX	Cyan DMX	Magenta DMX	Yellow DMX
Filter 4 (Medium Bastard Amber)	0	0	0	134	150
Filter 10 (Medium Yellow)	0	0	0	45	210
Filter 19 (Fire)	154	0	0	210	0
Filter 26 (Bright Red)	130	0	0	45	255
Filter 58 (Lavender)	0	0	10	205	93
Filter 68 (Sky Blue)	0	154	165	120	0
Filter 71 (Tokyo Blue)	144	0	0	0	0
Filter 79 (Just Blue)	0	154	165	135	0
Filter 88 (Lime Green)	0	142	0	90	0
Filter 90 (Dark Yellow Green)	0	142	201	0	147
Filter 100 (Spring Yellow)	0	0	0	0	210
Filter 101 (Yellow)	0	0	0	75	210
Filter 102 (Light Amber)	0	0	0	60	165
Filter 103 (Straw)	0	0	0	0	150
Filter 104 (Deep Amber)	0	0	0	150	225
Filter 105 (Orange)	0	0	0	195	240
Filter 106 (Primary Red)	154	0	0	240	0
Filter 111 (Dark Pink)	0	0	0	182	164
Filter 115 (Peacock Blue)	0	0	246	0	185
Filter 116 (Medium Blue-Green)	0	0	239	0	193
Filter 117 (Steel Blue)	0	0	180	90	165
Filter 118 (Light Blue)	0	0	225	0	165
Filter 119 (Dark Blue)	0	0	255	120	0
Filter 120 (Deep Blue)	0	154	255	30	0
Filter 121 (Filter Green)	0	142	135	0	210
Filter 128 (Bright Pink)	0	0	52	235	194
Filter 131 (Marine Blue)	0	0	210	15	135
Filter 132 (Medium Blue)	0	0	240	0	15
Filter 134 (Golden Amber)	0	0	49	201	237
Filter 135 (Deep Golden Amber)	0	0	49	223	254
Filter 136 (Pale Lavender)	0	0	64	198	131
Filter 137 (Special Lavender)	0	0	34	159	112
Filter 138 (Pale Green)	0	0	120	81	201
Filter 139 (Primary Green)	166	0	0	0	0
Filter 141 (Bright Blue)	0	0	240	0	45
Filter 147 (Apricot)	0	0	0	182	221
Filter 148 (Bright Rose)	0	0	0	225	217
Filter 152 (Pale Gold)	0	0	57	190	204
Filter 154 (Pale Rose)	0	0	57	185	189
Filter 157 (Pink)	0	0	59	224	223
Filter 158 (Deep Orange)	0	0	0	220	255
Filter 162 (Bastard Amber)	0	0	0	165	195
Filter 164 (Flame Red)	154	0	0	240	30
Filter 165 (Daylight Blue)	0	0	210	0	0
Filter 169 (Lilac Tint)	0	0	87	202	169
Filter 170 (Deep Lavender)	0	0	98	200	133

Colour name	Col. Wheel 1 DMX	Col. Wheel 2 DMX	Cyan DMX	Magenta DMX	Yellow DMX
Filter 172 (Lagoon Blue)	0	0	225	30	135
Filter 179 (Chrome Orange)	0	0	57	190	240
Filter 180 (Dark Lavender)	0	0	175	185	0
Filter 181 (Congo Blue)	0	0	195	225	0
Filter 197 (Alice Blue)	0	154	225	0	0
Filter 201 (Full C.T. Blue)	0	0	180	0	105
Filter 202 (Half C.T. Blue)	0	0	168	0	37
Filter 203 (Quarter C.T. Blue)	0	0	135	45	120
Filter 204 (Full C.T. Orange)	0	0	0	195	240
Filter 205 (Half C.T. Orange)	0	0	90	180	210
Filter 206 (Quarter C.T. Orange)	0	0	0	165	163
Filter 247 (Filter Minus Green)	0	0	0	184	131
Filter 248 (Half Minus Green)	0	0	48	134	110
Filter 281 (Three Quarter C.T. Blue)	0	0	180	0	105
Filter 285 (Three Quarter C.T. Orange)	0	0	0	173	234
Filter 352 (Glacier Blue)	0	0	210	0	105
Filter 353 (Lighter Blue)	0	0	220	0	144
Filter 715 (Cabana Blue)	0	154	255	0	0
Filter 778 (Millennium Gold)	0	0	0	215	255
Filter 793 (Vanity Fair)	0	0	15	225	0